

1

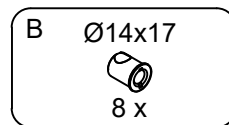

2

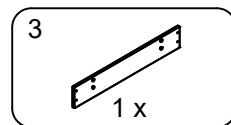

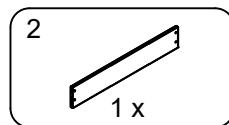
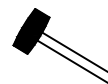
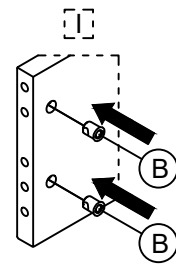
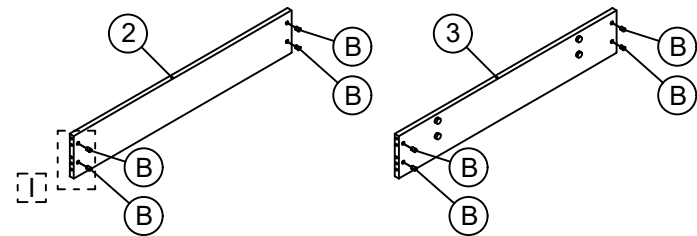
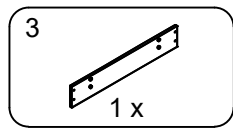
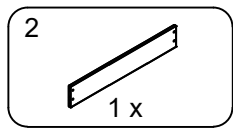
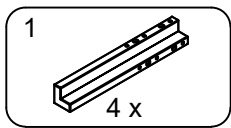

3

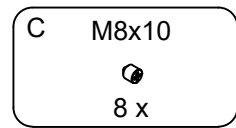

4

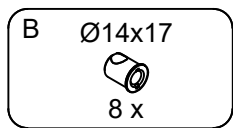
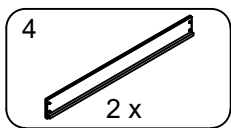
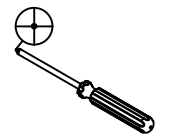
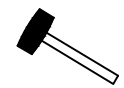
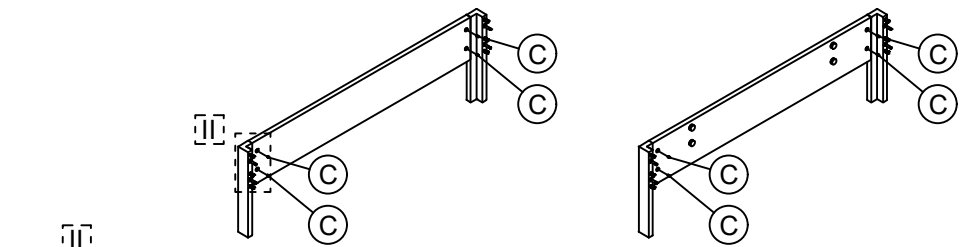
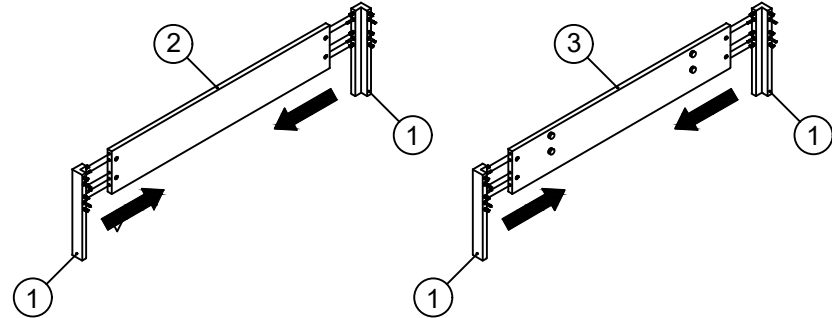

5

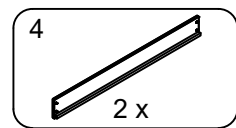

6

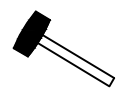
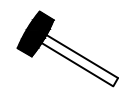
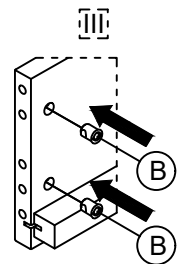
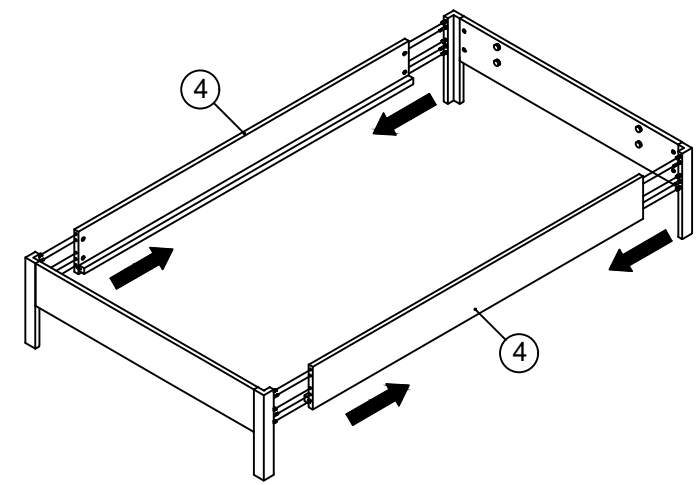
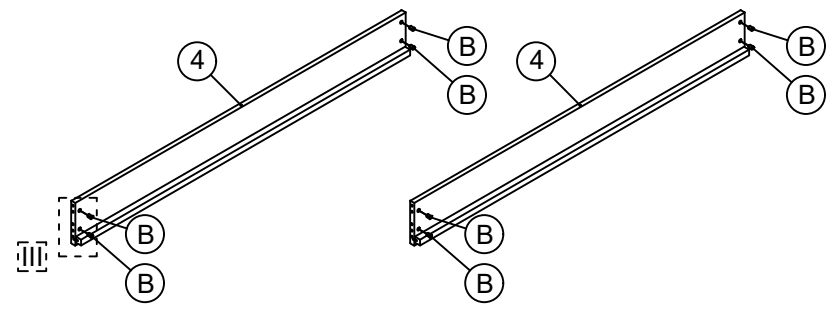

C M8x10
8 x

7

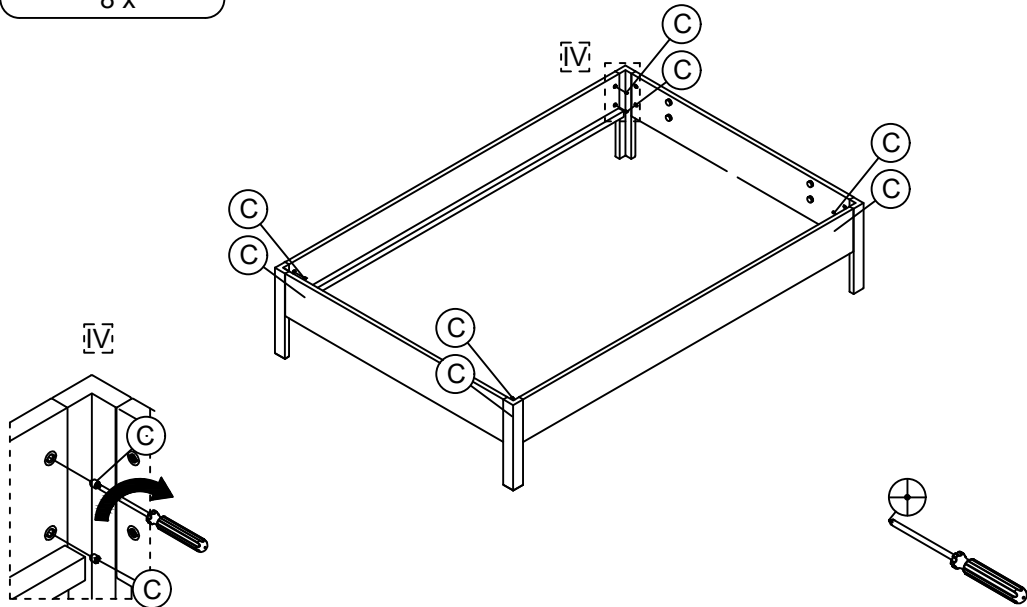

6
1 x

8

